

Spezifikation für Freigabe / specification for release

Kunde / customer :
 Artikelnummer / part number : **749023010**
 Bezeichnung : **LAN-Übertrager WE-LAN**
 description : **LAN-Transformer WE-LAN**



DATUM / DATE : 2006-03-24

A Mechanische Abmessungen / dimensions :

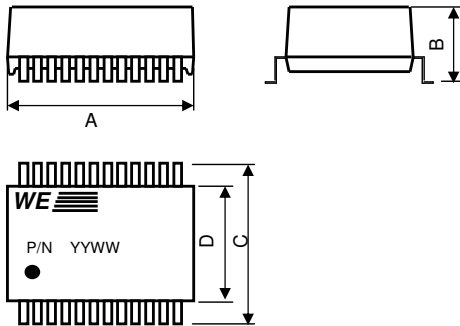

	1000 BaseT	
A	17,80 ± 0,25	mm
B	6,50 max.	mm
C	16,00 ± 0,25	mm
D	12,20 ± 0,25	mm

● = Pin 1

B Elektrische Eigenschaften / electrical properties :

Eigenschaften / properties	Testbedingungen / test conditions		Wert / value	Einheit / unit	tol.
Induktivität / Inductance	100kHz / 100mV @ 8mA DC Bias	OCL	350	μH	min.
Übersetzungsverhältnis / Turns ratio	100kHz / 100mV	TR	1 : 1	Tx	3%
			1 : 1	Rx	
Insertion Loss	0,1MHz	IL	-1.1	dB	max.
	100MHz		-1.0		
	125MHz		-2.0		
Return Loss	30MHz @ 100Ω	RL	-18	dB	min.
	60MHz @ 100Ω		-12		
	80MHz @ 100Ω		-12		
	100MHz @ 100Ω		-10		
Crosstalk	30MHz	DCMR	-43	dB	min.
	60MHz		-37		
	100MHz		-33		

C Lötpad / soldering spec. :

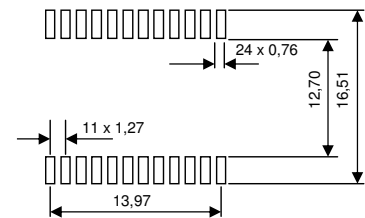

D Prüfgeräte / test equipment :

HP4395A

E Testbedingungen / test conditions :

Luftfeuchtigkeit / humidity: 33%
 Umgebungstemperatur / temperature: +25°C

F Werkstoffe & Zulassungen / material & approvals :

Basismaterial / base material: Ferrit/ ferrite
 Draht / wire: 4UEW 155°C
 Kontaktmaterial/ contact plating: Cu-Ni-Sn
 Gehäuse / case: UL94-V0
 Verguss / potting: UL94-V0

G Eigenschaften / general specifications :

Betriebstemp. / operating temperature: 0°C - + 70°C
 Hochspannungsprüfung / Hipot test: 1500Vrms 1min.
 geeignet für 1000BaseT-Anwendungen gemäß IEEE 802.3ab /
 Compliant with IEEE 802.3ab for 1000BaseT
 geeignet für Power over Ethernet-Anwendungen /
 suitable for Power over Ethernet applications

Freigabe erteilt / general release:

	Kunde / customer		
.....		
Datum / date	Unterschrift / signature		
	Würth Elektronik		
.....	TBr	Version 2 2006-03-24
		TBr	Version 1 2006-01-31
Geprüft / checked	Kontrolliert / approved	Name	Änderung / modification Datum / date

Würth Elektronik eiSos GmbH & Co.KG

D-74638 Waldenburg · Max-Eyth-Straße 1 - 3 · Germany · Telefon (+49) (0) 7942 - 945 - 0 · Telefax (+49) (0) 7942 - 945 - 400
<http://www.we-online.com>

Spezifikation für Freigabe / specification for release

Kunde / customer :
 Artikelnummer / part number : **749023010**
 Bezeichnung : **LAN-Übertrager WE-LAN**
 description : **LAN-Transformer WE-LAN**

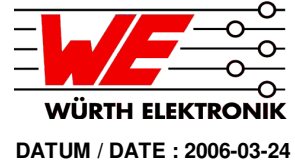

H Schaltbild / Schematics :

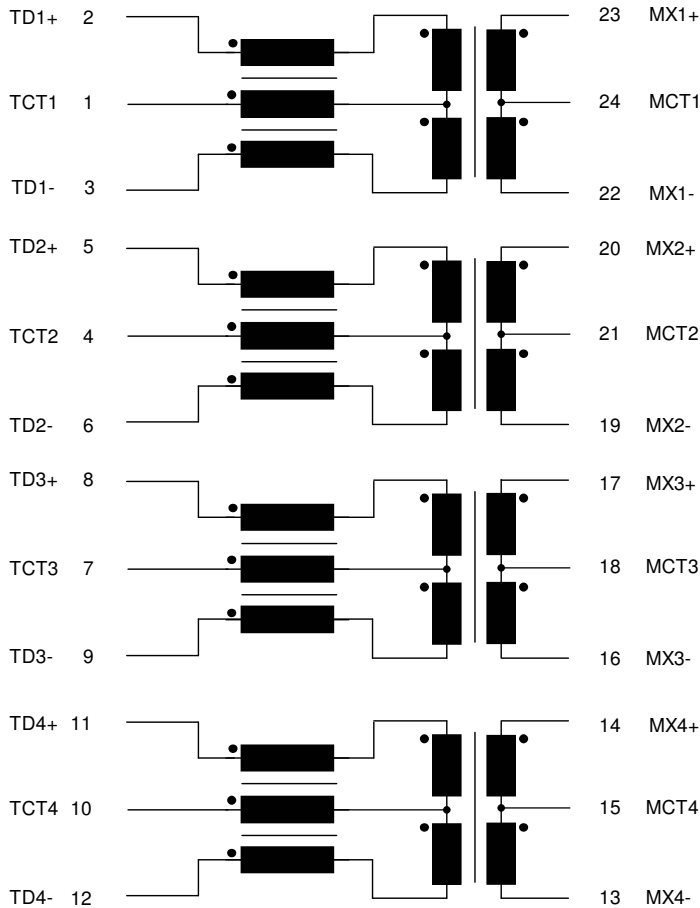

Freigabe erteilt / general release:	Kunde / customer			
.....			
Datum / date	Unterschrift / signature			
	Würth Elektronik			
.....	TBr	Version 2	2006-03-24
Geprüft / checked	Kontrolliert / approved	TBr	Version 1	2006-01-31
		Name	Änderung / modification	Datum / date

Würth Elektronik eiSos GmbH & Co.KG

D-74638 Waldenburg · Max-Eyth-Straße 1 - 3 · Germany · Telefon (+49) (0) 7942 - 945 - 0 · Telefax (+49) (0) 7942 - 945 - 400
<http://www.we-online.com>

Spezifikation für Freigabe / specification for release

Kunde / customer :
 Artikelnummer / part number : **749023010**
 Bezeichnung : **LAN-Übertrager WE-LAN**
 description : **LAN-Transformer WE-LAN**



DATUM / DATE : 2006-03-24

I Rollenspezifikation / tape and reel specification :

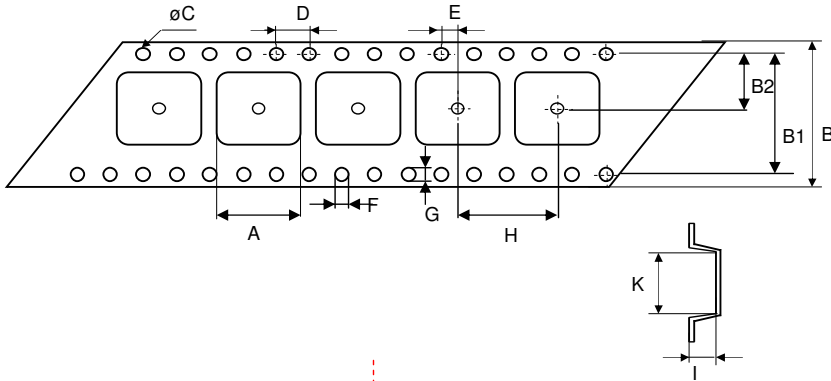

Gurtspezifikation / Tape specification:		
A	16,5 ± 0,1	mm
B	44,0 ± 0,3	mm
B1	40,4 ± 0,1	mm
B2	20,2 ± 0,1	mm
C	1,50 ^{+0,1} - 0,0	mm
D	4,00 ± 0,1	mm
E	2,00 ± 0,1	mm
F	1,50 ^{+0,1} - 0,0	mm
G	1,70 ^{+0,15} - 0,05	mm
H	24,0 ± 0,1	mm
I	6,5 ± 0,1	mm
K	18,5 ± 0,1	mm

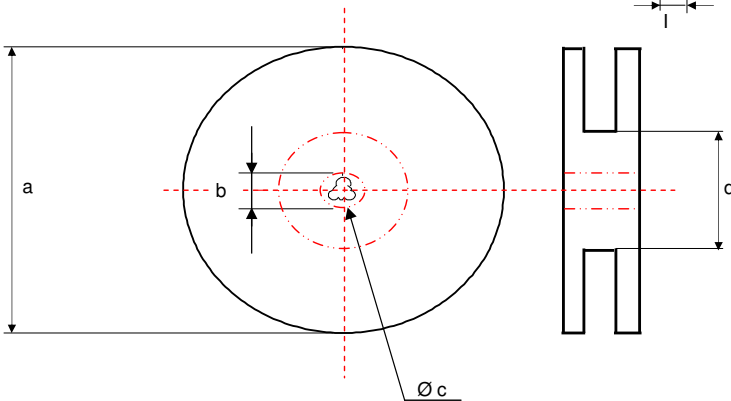

Rollenspezifikation / Reel specification:		
a	330,0 ± 2,0	mm
b	21,00 ± 0,8	mm
c	13,50 ± 0,5	mm
d	100,0 ± 1,0	mm

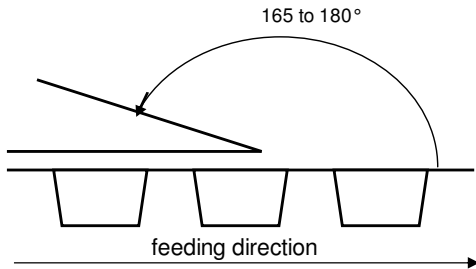

The force for tearing off cover tape is 10 to 130 grams in arrow direction

Freigabe erteilt / general release:	Kunde / customer		
		
Datum / date	Unterschrift / signature		
	Würth Elektronik		
Geprüft / checked	Kontrolliert / approved		
	Name	Änderung / modification	Datum / date
	TBr	Version 2	2006-03-24
	TBr	Version 1	2006-01-31

This electronic component has been designed and developed for usage in general electronic equipment. Before incorporating this component into any equipment where higher safety and reliability is especially required or if there is the possibility of direct damage or injury to human body, for example in the range of aerospace, aviation, nuclear control, submarine, transportation, (automotive control, train control, ship control), transportation signal, disaster prevention, medical, public information network etc, Würth Elektronik eiSos GmbH must be informed before the design-in stage. In addition, sufficient reliability evaluation checks for safety must be performed on every electronic component which is used in electrical circuits that require high safety and reliability functions or performance.

Würth Elektronik eiSos GmbH & Co.KG

D-74638 Waldenburg · Max-Eyth-Straße 1 - 3 · Germany · Telefon (+49) (0) 7942 - 945 - 0 · Telefax (+49) (0) 7942 - 945 - 400
<http://www.we-online.com>